



User Manual

Version 1.5

DC System Monitor: FR-DCMG-MMPS



Scan the code to learn more
Fonrich (Shanghai) New Energy Technology Co., Ltd.

Add: 1st Floor, Building 5, No.999 Jianguye Road, Minhang District, Shanghai
Web: www.fonrich.com
Tel: +86 21 61679671
Email: sales@fonrich.com

Table of Contents

Table of Contents	1
1 Documentation statement	3
2 Safety Precautions	3
2.1 Signs.....	3
2.2 Safety Precautions.....	3
2.3 Personnel requirements.....	3
2.4 Electrical connection.....	4
2.5 System running.....	4
3 Product description	5
3.1 The main function.....	5
3.2 Terminal Definition.....	6
4 Wiring diagram of monitoring module	7
4.1 Electrical wiring diagram.....	7
4.2 Ground connection and RS485 communication shielded wire.....	8
5 UI introduction	9
5.1 Key operation.....	9
5.2 Boot interface.....	9
5.3 Current interface.....	9
5.4 Channel current data.....	10
5.5 Parameter settings.....	10
5.6 Trip self-test setting interface.....	11
5.7 Current calibration setting interface.....	12
5.8 System information display interface.....	12
5.9 Alarm status display interface.....	13
5.10 DC arc fault alarm interface.....	13
5.11 Fault alarm clear interface.....	13
6 Alarm information management	14
6.1 Items that can generate alarms can be set.....	14
6.2 Items that can be tripped by setting.....	14
6.3 Alarm conditions.....	15
6.3.1 Alarm judgment condition.....	15
6.3.2 Trip judgment condition.....	15
6.4 Alarm message.....	15
6.5 Arc Alarm Strategy.....	15
6.5.1 Arc mode.....	15
6.5.2 Arc alarm strategy.....	16

6.5.3 Arc alarm time.....	16
6.6 Combined alarm strategy (closed by default, follow the steps below when needed).....	16
7 MODBUS Protocol Definition.....	17
7.1 Communication format configuration.....	17
7.2 Data frame format description (refer to Modbus RTU standard).....	17
7.2.1 Data message example.....	17
7.3 Function code description.....	18
Register reads and writes in bits.....	18
Register read and write in word units.....	18
7.4 Register description.....	18
7.4.1 Register description in bit units (function code 02).....	18
7.4.2 Register description in word unit (function code 03 04 06).....	30
8 Appendix.....	38
8.1 Document revision record.....	38
8.2 Contact us.....	39





1 Documentation statement

This manual applies to the product model FR-DCMG-MMPS, and the software version is A08D.

2 Safety Precautions

2.1 Signs

The following signs may appear in this article, and their meanings are as follows.

Signs	Instructions
	Indicates a hazardous situation which, if not avoided, will result in death or serious injury.
	Indicates a hazardous situation which, if not avoided, could result in death or serious injury.
	Indicates a hazardous situation which, if not avoided, could result in minor or moderate injury.
	Indicates a situation which, if not avoided, can result in property damage. It is not safety warning information, and does not involve personal, equipment and environmental damage.
	Protrudes important or critical information, best practices, tips, etc. It is not safety warning information, and does not involve personal, equipment and environmental damage.

2.2 Safety Precautions

Please read the safety precautions in this user manual carefully to avoid personal injury and property damage.

2.3 Personnel requirements

The installation and operation of FR-DCMG-MMPx must be carried out by a professional electrician.

The operator should be fully familiar with the composition and working principle of the entire photovoltaic grid-connected power generation system, as well as the relevant standards of the country/region where the project is located.



Live operation is strictly prohibited during installation. Before installation, make sure that both the DC side and the AC side are powered off.

NOTICE

Please read this user manual carefully before installation. If the equipment is damaged due to failure to install in accordance with this user manual, our company reserves the right not to guarantee the quality.

- Before installation, make sure that it is not electrically connected and powered on.
- During the installation process, except for the wiring terminals of the arc box, please do not touch other parts inside.
- Before making electrical connections, make sure that the voltage of the positive and negative poles of the DC busbar of the combiner box is 0V.

2.4 Electrical connection



Before electrical connection, please make sure that FR-DCMG-MMPx is not damaged and in a safe state, otherwise it may cause electric shock.

- All electrical connections must meet the electrical standards of the country/region where they are located.
- The cables used in the PV combiner box must be firmly connected, well insulated, and have appropriate specifications.

2.5 System running



FR-DCMG-MMPx has high voltage during operation, which may cause electric shock or death in severe cases. Please operate strictly in accordance with the safety precautions listed in this manual and other related documents.

3 Product description

FR-DCMG DC monitor products are mainly used in DC transmission, power distribution and other occasions, such as photovoltaic combiner boxes, arc protection boxes, etc. Through RS485 communication with the host computer, its main functions include real-time monitoring of the current of each branch in the DC system, the temperature of the cabinet, the status of the lightning arrester and the status of the DC circuit breaker, etc. It can realize automatic alarm for abnormal conditions and real-time detection of harmful arcs in the DC circuit. Once there are harmful arcs, an alarm signal will be sent immediately to directly drive the trip unit and cut off the fault circuit, thereby effectively preventing potential safety hazards such as fires caused by arcs.

3.1 The main function

- **Monitoring function:** real-time monitoring of the generation current, voltage, temperature of the combiner box, lightning protector status, DC circuit breaker status, and DC arc fault status of each photovoltaic string in the combiner box, and communicate with the host computer through RS485.
- **Display content:** For the detected current, temperature, switch status and other data, FR-DCMG-MMPS can display histogram interface through LCD, and read current and other data more intuitively.
- **Alarm function:** According to the actual needs of the site, it can be configured to turn on or off the alarm and shunt release functions (by default, only the arc alarm and trip functions are turned on). When alarming, the interface pops up alarm information.
- **Tripping mode switching:** The default O+, O- voltage is 0V, and the voltage output is 24V when tripping, or it can be set to the opposite application.

3.2 Terminal Definition

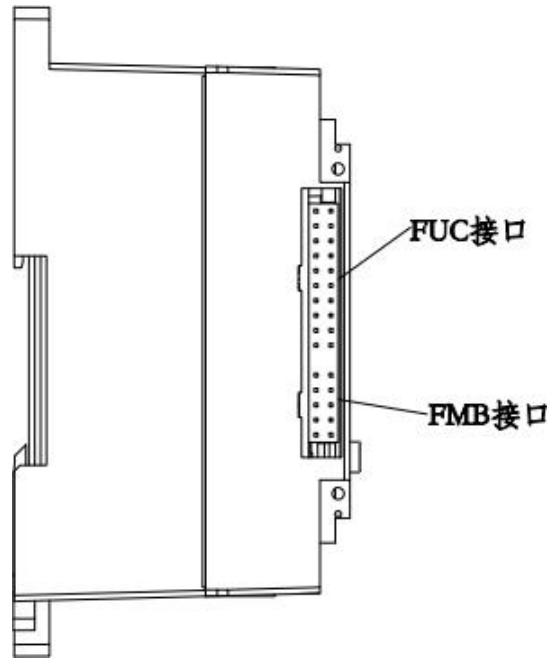
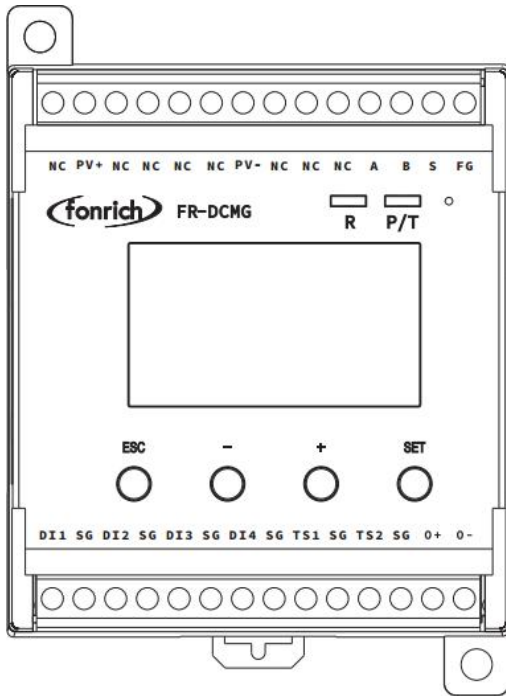

Symbol	Meaning
PV+/PV-	Measuring voltage
NC	Not connection
S	Not connection
A/B	RS485 Communication terminal
FG	Fixed Ground terminal
TS1/TS2	Externally connected temperature sensor terminals
SG	Temperature sensor and digital input ground terminal
DI1/DI2/DI3/DI4	4 digital input terminals
O+/O-	Connecting the shunt release
FUC	Can connect modules with FUC interface
FMB	Modules with an FMB interface can be connected, such as the FR-DCMG-AS4A DC Arc Detector.
O+/SG	24V power supply terminal, O+ connects to 24V+, SG connects to 24V-

4 Wiring diagram of monitoring module

4.1 Electrical wiring diagram

Note: O+ is connected to 24V+, SG is connected to 24V-, if the connection is reversed, the module may be damaged

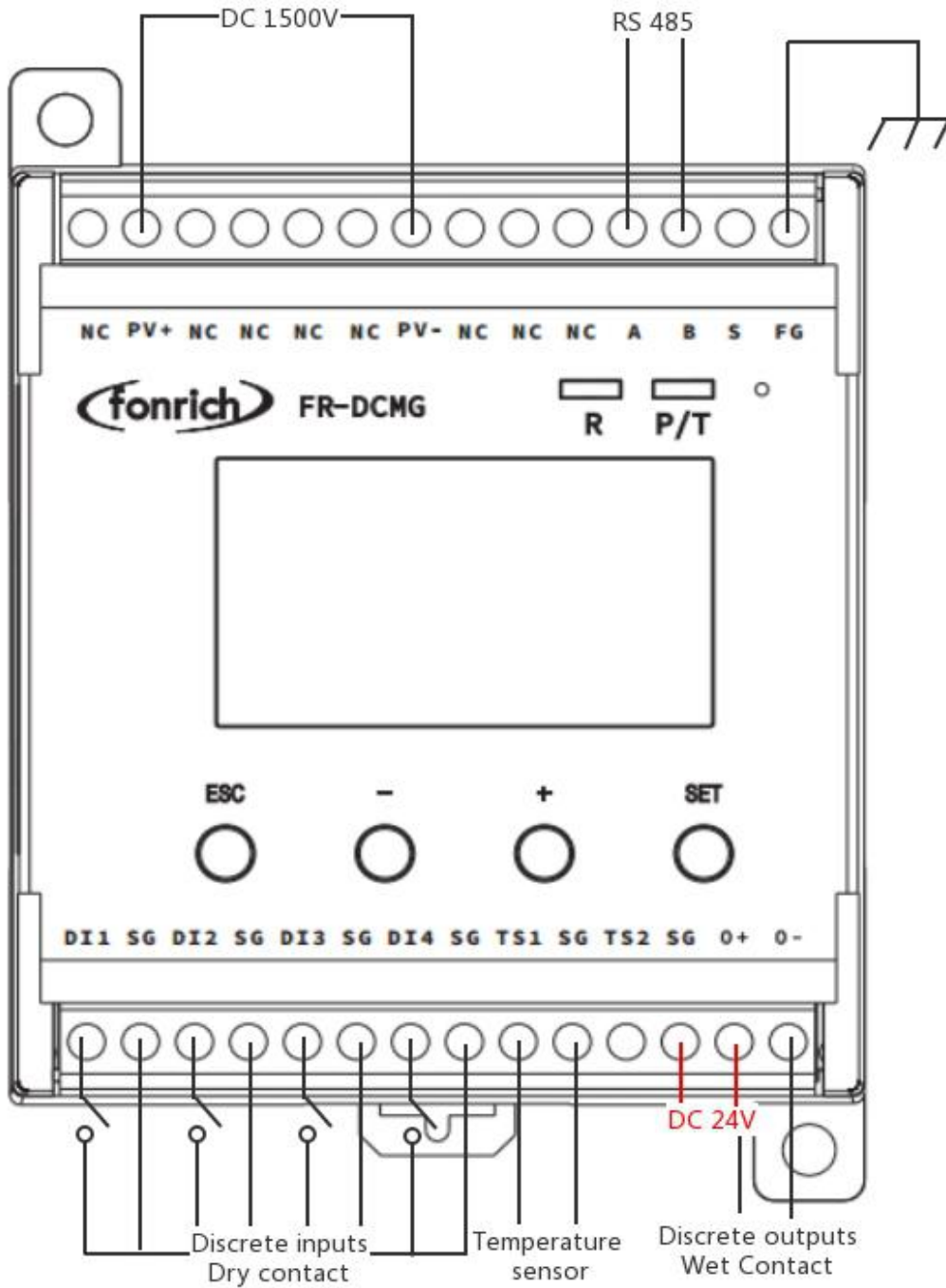

4.2 Ground connection and RS485 communication shielded wire

The FG terminal of the FR-DCMG must be grounded, otherwise communication will interfere and the reliability of the device will decrease. The grounding wire should be grounded nearby. The grounding wire should be no more than 15cm from the “FG” terminal to the bottom of the combiner box. It is recommended to be within 10cm. The shorter the better, the thicker the better. The bottom of the combiner box should be connected to the ground. The main control unit module is fixed on a standard guide rail with a width of 3.5 cm.

The wiring specification of the communication shielded wire is shown in the figure below:

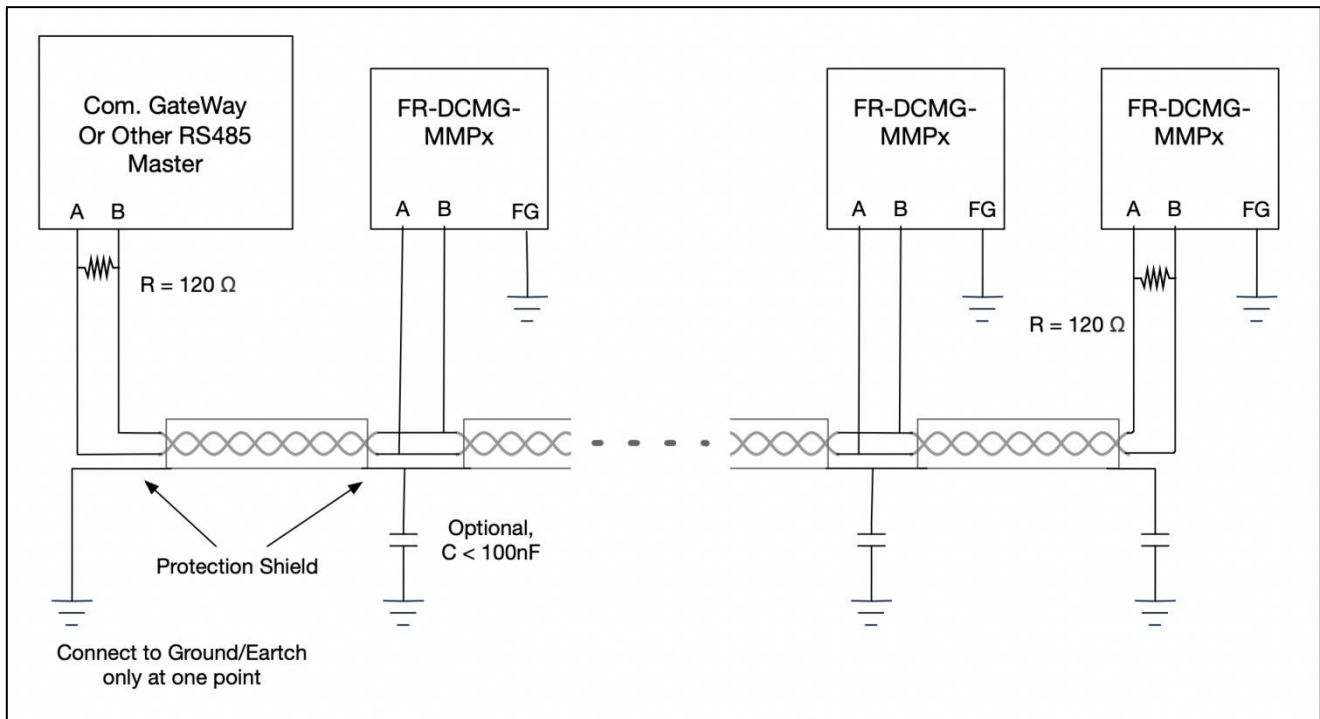

The wiring of on-site communication lines requires that the communication shield can only be grounded at a single point, otherwise there will be a risk of lightning surge damage to all equipment on the entire communication line during a lightning strike;

If you encounter a situation where communication line interference is too large to communicate, you can refer to the figure above, and insert a high voltage capacitor $C < 100\text{nF}$ between the shielded wire of each combiner box and the ground wire, and use this capacitor to filter the shielding layer interference.

5 UI introduction

5.1 Key operation

FR-DCMG-MMPS has four keys "ESC", "-", "+", and "SET".

"ESC" key is used to return to the default interface and cancel parameter settings;

"SET" key is used to enter the parameter setting mode, select the parameter to be set and complete the setting of the parameter;

The "+" and "-" keys are used to scroll the screen and adjust parameters;

Press the "+" and "-" keys at the same time to display the software version interface;

Press the "ESC" and "-" keys simultaneously to display the current calibration interface;

Press the "ESC" and "+" keys simultaneously to display the trip self-test interface;

If there is no key operation for 10 seconds, the interface will automatically jump to the default interface of the current mode, and the brightness will decrease after 5 seconds.

5.2 Boot interface

After the device is powered on, the following interface will be displayed:

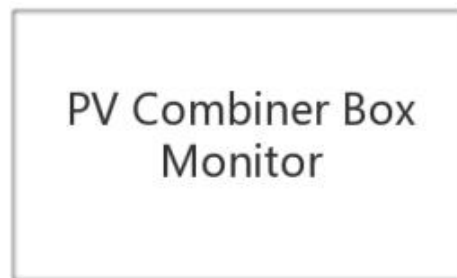

5.3 Current interface

After the boot interface, the histogram interface will be displayed, as shown below:

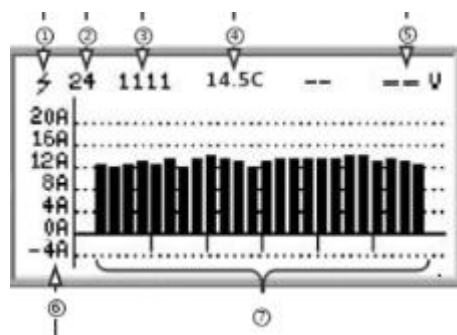

① It indicates that the connected Hall has the arc detection function, and the ordinary Hall does not have this mark;

② The number of online current channels varies according to the number of Halls actually connected;

③ Switch input status: DI1, DI2, DI3, DI4 real-time status;

④ Real-time temperature;

⑤ No voltage displayed when PV+/PV- is not connected;

- ⑥ Current histogram; the default display range is -4A ~ 20A, and the display range can be expanded by setting register 0x0B16;
- ⑦ Histogram partition: because 6 Halls are inserted, 6 partitions

5.4 Channel current data

In the current interface, press the "+" or "-" key to enter the channel current display interface, and the current value of each channel is displayed on the screen. You can scroll through the screen by continuing to press the "+" or "-" key. The picture above is the current display interface. "CH1:" in the above figure indicates that the real-time monitoring current value of channel 1 is "6.929A", and so on.

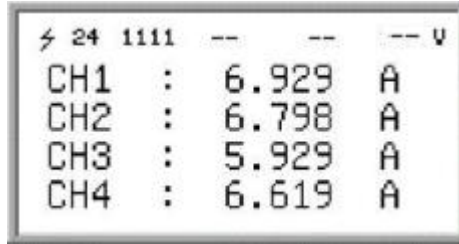

5.5 Parameter settings

5.5.1 Press the "SET" key to enter the Modbus parameter setting interface. The Modbus parameter setting is as shown in the figure below:

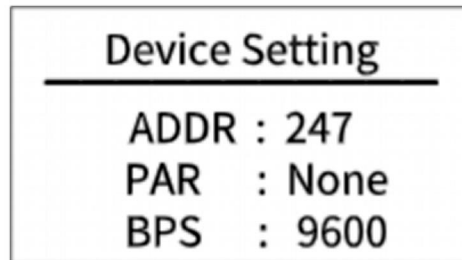

- **ADDR:** The communication address of the Modbus slave node, the range is 1 ~ 247 (default is 247).
- **PAR:** The data verification method of Modbus communication. The optional parity (None), odd parity (Odd), even parity (Even), and no parity by default.
- **BPS:** Baud rate for Modbus communication. The selectable baud rates are 2400, 4800, 9600 (default), 19200, 38400.

5.5.2 Press the "+" key to select down to the second page of the setting interface

Note: For details, please refer to the FR-DCMG-MMPL manual, Press "+" key to go to the next page.

PLC Setting	
MODE	: Node
BAND	: CENA
NID	: 0

5.5.3 Press the "+" key to continue to select downwards to the arc parameter setting interface:

ARC Setting	
MOD	: Cont
THR	: 50
IAT	: 2

- **MOD:** Arc protection mode (Cont: continuous Arc Alarm mode, Single: Instantaneous Arc alarm mode)
- **THR:** Arc threshold (default 50)
- **IAT:** 2 (Instantaneous Arc Time, default 2)

5.5.4 Press the "+" key to continue to select downwards to the arc parameter setting interface:

System Setting	
CAT	: 15
LANG	: EN

- **CAT:** Continuous Arc Time (default 15)
- **LANG:** Language setting (default: EN)

5.6 Trip self-test setting interface

Press "ESC" and "+" at the same time to enter the shunt tripping setting interface.
Release mode (O+/O- DC voltage is 0v), the interface is as follows:

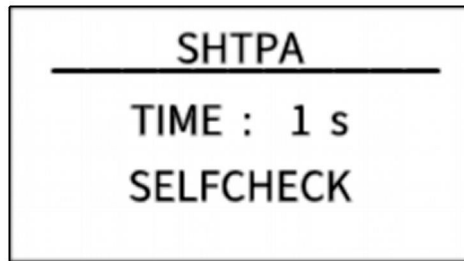

(Factory default) Relay mode (O+/O- DC voltage is 24v), the interface is as follows:

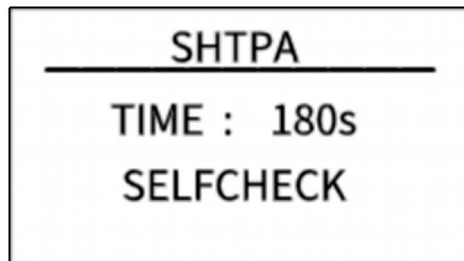

On the shunt trip setting interface, you can set the shunt trip enable time (TIME) and trip self-check (SELFCHECK) when an arc alarm occurs.

When the "*" flashes in the TIME line, press the "SET" key, and then press "+" or "-" to modify the shunt release time.

When "*" flashes in the SELFCHECK line, press the "SET" key to automatically perform the self-check of the shunt release.

The specific performance is: when the time is reached, the shunt release will act, and after the enabling time, the shunt release will recover.

5.7 Current calibration setting interface

Press the "ESC" and "-" keys at the same time to enter the current calibration setting interface, as shown below:

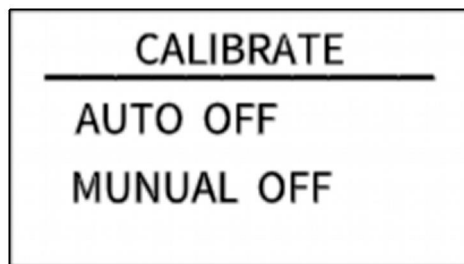

Note: To use this feature, please contact the company's technical support staff.

5.8 System information display interface

In the histogram interface, press the "+" and "-" keys at the same time to enter the software version number display interface, as shown below:

```
CBM Information
-----
HV : FFFF
SV : A08D
ST : 0
```

- HV : —
- SV : Software version number
- ST : —

5.9 Alarm status display interface

Alarm messages can be cleared remotely and manually. Manual clearing requires long-pressing the host's "ESC" key for 2 seconds, remote clearing requires writing "1" to register 0x0079 to clear. If an arc trip alarm occurs, it must be cleared manually or remotely. Restarting the host will still display the alarm message.

5.10 DC arc fault alarm interface

After the DC arc sensor detects the occurrence of a fault arc, the alarm information interface of the host is as shown below.

```
ALARM TRIP
-----
02 — 4
CH Arc Alarm
```

In the figure above: "02" means channel arc fault alarm, and "4" means that the fault arc alarm channel is 4.

5.11 Fault alarm clear interface

The host sends an alarm when it detects a fault, and the user can choose to handle it locally or remotely. By long-pressing the "ESC" key for about 5 seconds locally, the system jumps out of the interface as shown below, indicating that the alarm status has been cleared; remote processing needs to write "1" to 0x0079 to clear, and the interface shown below will be displayed after clearing successfully.

```
Clear Alarm ST
```

6 Alarm information management

6.1 Items that can generate alarms can be set

Channel arc
Voltage is too high
Voltage is too low
Temperature is too high
Channel reverse current
Total reverse current is too high
Total current is too high
Total current is too low
Channel without current
Low channel current
High channel current
Channel current value undercurrent
Channel current value overcurrent
Switch DI1 status
Switch DI2 status
Switch DI3 status
Switch DI4 status

6.2 Items that can be tripped by setting

Channel arc
Voltage is too high
Temperature is too high
Channel reverse current
Total reverse current is too high
Total current is too high
Channel without current
Low channel current
High channel current
Channel current value undercurrent
Channel current value overcurrent
Switch DI1 status
Switch DI2 status
Switch DI3 status
Switch DI4 status

6.3 Alarm conditions

6.3.1 Alarm judgment condition

Prerequisites for alarm judgment of channels such as reverse current, no current, undercurrent, overcurrent, low current, and high current:

- a. When the average value of the channel current is greater than the set [current channel alarm activation threshold](#), the alarm function of the above current-related items will be activated, otherwise the alarm status will be forced to clear to 0;
- b. As for whether the alarm needs to meet the respective alarm conditions (above or lower than the respective alarm threshold).
- c. Confirm whether the corresponding [alarm register](#) is turned on. By default, only the channel arc alarm is turned on; Current reverse, no current, under current, over current, low current, high current, etc. Channel alarm and trip judgment preconditions:

6.3.2 Trip judgment condition

Reverse current, no current, under current, over current, low current, high current channel alarm and trip judgment prerequisites:

- a. They need to meet their alarm conditions.
- b. At the same time, when the cumulative number of alarm channels is greater than the set [number of trip channels](#), a trip will occur.
- c. Confirm whether the corresponding [trip register](#) is open, the default is closed

6.4 Alarm message

- Undercurrent alarm. After the channel average current value is subtracted from the overcurrent / undercurrent alarm threshold, the current value is still less than or equal to the current channel start alarm start threshold. The overcurrent / undercurrent alarm threshold will change as the average current changes.
- Over current alarm. After the channel average current value plus the over current / under current alarm threshold, the current value is still greater than or equal to the current channel start alarm start threshold. The over current / under current alarm threshold will change as the average current changes.
- Low current alarm, when the current is less than or equal to the channel current low alarm threshold, an alarm occurs.
- High current alarm. When the current is greater than or equal to the channel current high alarm threshold, an alarm occurs.
- No current alarm, when the absolute value of the current is less than 250mA, an alarm occurs.

6.5 Arc Alarm Strategy

6.5.1 Arc mode

We divide the arcs into Instantaneous Arc and Continuous Arc.

Instantaneous Arc

The arc duration does not exceed the Instantaneous Arc Time (IAT), and there is no arc occurring again within the Continuous Arc Time (CAT).

Continuous Arc

The arc duration exceeds the IAT, or the arc duration does not exceed the IAT, but the arc occurs again within the CAT.

6.5.2 Arc alarm strategy

1. Instantaneous arc alarm

If the arc intensity of any channel exceeds the channel alarm threshold, an arc alarm will be generated.

2. Continuous arc alarm

The product does not alarm when instantaneous arc is detected, but only when continuous arc is detected.

6.5.3 Arc alarm time

The calculation method of the arc alarm times of the channel: When an arc alarm occurs in any channel, the number of arc alarm times increases by 1. When arc faults occur in several channels at the same time, the number of arc alarm times only increases by 1. The product will automatically restart after 2 minutes.

However, when the arc alarm times is up to the value of the arc alarm time, the device must be restarted manually.

6.6 Combined alarm strategy (closed by default, follow the steps below when needed)

The alarm will only take effect when two or more alarm conditions are met at the same time

Example: Simultaneously meet-when the voltage is lower than 800V and the total current is greater than 50A, the module will alarm and trip.

operate:

Step 1: Turn on bit4 of 0x0B21 (2849) and 0x0B24 (2852);

Step 2: Turn on the low voltage (Bit2) and total current too high (Bit9) functions of 0x0B26 (2854);

Step 3: Turn on the alarms of 0x0B20 (2848) and 0x0B23 (2851) corresponding to low voltage (Bit2) and high total current (Bit9);

Step 4 (optional): Set 0x0B05 (2821) total current too low,

The total current of 0x0B06 (2822) is too high,

The 0x0B01 (2817) voltage is too low, and the threshold of these 3 data is adjusted to a value that meets the test conditions

illustrate:

- The status of the combined alarm is kept consistent with the register locations of other alarms
- The status of the combined alarm 03 The position of the function code is in bit 4 of the register 0x12B and 0x12E
- The status of the combined alarm 02 The position of the function code is 0x214 in the register

7 MODBUS Protocol Definition

7.1 Communication format configuration

- Modbus communication mode: RTU mode
- Address of the slave device: range form 1 to 247 (default 247)
- Baud rate (bps): 2400, 4800, 9600 (default), 19200, 38400
- Byte check mode: odd check, even check, no check (default)

7.2 Data frame format description (refer to Modbus RTU standard)

The byte in the communication frame composed by 1 start bit, 8 bits data bit, 1 parity bit, 1 stop bit like the below table (Refer to standard modbus RTU protocol):

Table 1: Data frame format table

Address Code	Function Code	Data Area	Check Zone
1byte	1byte	N*1byte	2bytes

The address code is used to identify the slave that receives the data frame and the response frame sent by that slave. The function code indicates how the master requires the slave to respond and the slave responds to that function code. Data area The content can be the address value, the number of registers, the data from the slave response and the data sent by the master to the slave, etc., which can hold up to 252 bytes of data. The check area uses CRC cyclic redundancy to check whether a frame of data is wrong. The high byte of the data frame comes first, and the low byte comes after.

7.2.1 Data message example

Send: 01 03 01 04 00 01 C4 37
 Device address Register address Check digit (automatically generated)
 function code Number of registers

Receive: 01 03 02 02 BC B8 95
 Device address Number of bytes Check digit (automatically generated)
 function code Number of registers

Message example analysis: The above sending message reads the value of slave address 1 and register address 0x0104 (voltage V), and the received message responds with voltage data 0x02BC, which is converted to decimal, which is 700V.

7.3 Function code description

Register reads and writes in bits

- Function code 01 used to read the contents of the bit register
- Function code 02 used to reads the contents of the bit register
- Function code 05 used to write single bit-type registers
- The contents represented by the register in bits are: switch value, alarm information, etc.

Register read and write in word units

- Function codes 03、04 are used to read multiple word-type registers
- Function code 06 is used to write single word-type registers
- Function code 16 is used to multiple word-type registers
- The content of the word-type registers can be voltage, current, generated energy, etc

7.4 Register description

7.4.1 Register description in bit units (function code 02)

Bit address		Functional description	remark
Hex	Decimal		
0x0200	512	Bus arc trip state	The bus arc is faulted and a trip is performed and this bit is set. Clear the alarm and set it to 0.
0x0201	513	Channel arc trip state	The channel arc is faulted and a trip is performed and this bit is set. Clear the alarm and set it to 0.
0x0203	515	Bus voltage is too high trip state	The bus voltage is high and an trip is performed and this bit is set. Clear the alarm and set it to 0.
0x0204	516	Temperature sensor 1 over temperature and high trip state	The temperature sensor 1 overtemperature alarm and performs a tripping action, this bit is set to 1. Clear alarm after setting 0.
0x0205	517	Temperature sensor 2 over temperature and high trip state	The temperature sensor 2 overtemperature alarm and performs a tripping action, this bit is set to 1. Clear alarm after setting 0.
0x0206	518	Channel reverse current trip state	This bit is set to 1 when the channel current is reversed and the trip condition is met and a trip is performed. Clear alarm after

			setting 0.
0x0207	519	Total reverse current trip state	The total reverse current alarm and a trip action is performed and this bit is set. Clear the alarm and set it to 0.
0x0209	521	Total current is too high trip state	The total current is high and an trip is performed and this bit is set. Clear the alarm and set it to 0.
0x020A	522	Channel no current trip state	This bit is set to 1 when the channel has no current alarm and the trip condition is met and a trip is performed. Clear alarm after setting 0
0x020B	523	Channel undercurrent trip state	This bit is set to 1 when the channel undercurrent alarm is met and the trip condition is fulfilled and a trip is performed. Clear alarm after setting 0
0x020C	524	Channel overcurrent trip state	This bit is set to 1 when the channel is overcurrent and the trip condition is met and a trip is performed. Clear alarm after setting 0
0x020D	525	Channel current is too low to trip state	This bit is set to 1 when the channel current is low and the trip condition is met and a trip is performed. Clear alarm after setting 0
0x020E	526	Channel current is too high to trip state	This bit is set to 1 when the channel current is high and the trip condition is met and a trip is performed. Clear alarm after setting 0
0x0210	528	Switch 1 trip status	Switch 1 performs a trip action
0x0211	529	Switch 2 trip status	Switch 2 performs a trip action
0x0212	530	Switch 3 trip status	Switch 3 performs a trip action
0x0213	531	Switch 4 trip status	Switch 4 performs a trip action
0x0214	532	Combined alarm trip status	Combined alarm trip action
.....
0x021E	542	Remote manual trip status	The remote manual control release performs a trip action and this bit is set to 1. Clear alarm after setting 0
0x0230	560	Bus arc alarm status	This bit is set when the bus arc strength is above the alarm threshold. Clear the alarm and set it to 0
0x0231	561	Channel arc alarm status	This bit is set when the channel arc strength is above the alarm threshold. Clear the alarm and set it to 0
0x0232	562	Bus voltage too low alarm status	This bit is set when the bus voltage is below the alarm threshold. Cleared below the alarm release threshold
0x0233	563	Bus voltage to high alarm status	This bit is set when the bus voltage exceeds the alarm threshold. Cleared below the alarm release threshold

0x0234	564	Temperature sensor 1 high temperature alarm status	This bit is set when the temperature sensor 1 temperature exceeds the alarm threshold. Cleared below the alarm release threshold
0x0235	565	Temperature sensor 2 high temperature alarm status	This bit is set when the temperature sensor 2 temperature exceeds the alarm threshold. Cleared below the alarm release threshold
0x0236	566	Channel reverse current alarm status	When the reverse current is generated in the channel, the position is 1, and the alarm is cleared.
0x0237	567	Total reverse current alarm status	This bit is set when the total reverse current exceeds the alarm threshold. Cleared below the alarm release threshold
0x0238	568	Total current too low alarm state	This bit is set when the total current exceeds the alarm threshold. Cleared below the alarm release threshold
0x0239	569	Total current too high alarm state	This bit is set when the total current exceeds the alarm threshold. Cleared below the alarm release threshold
0x023A	570	Channel current value zero	The channel has no current alarm and this bit is set to 1
0x023B	571	Channel current value undercurrent	Channel undercurrent alarm, this bit is set to 1
0x023C	572	Channel current value overcurrent	Channel overcurrent alarm, this bit is set to 1
0x023D	573	Channel current value is too low	Channel current low alarm, this bit is set to 1
0x023E	574	Channel current value is too high	Channel current high alarm, this bit is set to 1
0x0240	576	Switch 1 alarm status	The state of the device's input switch DI1, 0: open, 1: closed
0x0241	577	Switch 2 alarm status	The state of the device's input switch DI2, 0: open, 1: closed
0x0242	578	Switch 3 alarm status	The state of the device's input switch DI3, 0: open, 1: closed
0x0243	579	Switch 4 alarm status	The state of the device's input switch DI4, 0: open, 1: closed
.....
0x0260	608	Channel 1 arc alarm status	When the arc intensity of the channel is greater than the alarm threshold, this bit is set to 1; after clearing the alarm, it is set to 0
0x0261	609	Channel 2 arc alarm status	When the arc intensity of the channel is greater than the alarm threshold, this bit is set to 1; after clearing the alarm, it is set to 0
0x0262	610	Channel 3 arc alarm status	When the arc intensity of the channel is greater than the alarm threshold, this bit is set to 1; after clearing the alarm, it is set to 0
0x0263	611	Channel 4 arc alarm status	When the arc intensity of the channel is greater than the alarm threshold, this bit is set to 1; after clearing the alarm, it is set to 0
0x0264	612	Channel 5 arc alarm status	When the arc intensity of the channel is greater than the alarm threshold, this bit is set to 1; after clearing the alarm, it is set to 0

0x0265	613	Channel 6 arc alarm status	When the arc intensity of the channel is greater than the alarm threshold, this bit is set to 1; after clearing the alarm, it is set to 0
0x0266	614	Channel 7 arc alarm status	When the arc intensity of the channel is greater than the alarm threshold, this bit is set to 1; after clearing the alarm, it is set to 0
0x0267	615	Channel 8 arc alarm status	When the arc intensity of the channel is greater than the alarm threshold, this bit is set to 1; after clearing the alarm, it is set to 0
0x0268	616	Channel 9 arc alarm status	When the arc intensity of the channel is greater than the alarm threshold, this bit is set to 1; after clearing the alarm, it is set to 0
0x0269	617	Channel 10 arc alarm status	When the arc intensity of the channel is greater than the alarm threshold, this bit is set to 1; after clearing the alarm, it is set to 0
0x026A	618	Channel 11 arc alarm status	When the arc intensity of the channel is greater than the alarm threshold, this bit is set to 1; after clearing the alarm, it is set to 0
0x026B	619	Channel 12 arc alarm status	When the arc intensity of the channel is greater than the alarm threshold, this bit is set to 1; after clearing the alarm, it is set to 0
0x026C	620	Channel 13 arc alarm status	When the arc intensity of the channel is greater than the alarm threshold, this bit is set to 1; after clearing the alarm, it is set to 0
0x026D	621	Channel 14 arc alarm status	When the arc intensity of the channel is greater than the alarm threshold, this bit is set to 1; after clearing the alarm, it is set to 0
0x026E	622	Channel 15 arc alarm status	When the arc intensity of the channel is greater than the alarm threshold, this bit is set to 1; after clearing the alarm, it is set to 0
0x026F	623	Channel 16 arc alarm status	When the arc intensity of the channel is greater than the alarm threshold, this bit is set to 1; after clearing the alarm, it is set to 0
0x0270	624	Channel 17 arc alarm status	When the arc intensity of the channel is greater than the alarm threshold, this bit is set to 1; after clearing the alarm, it is set to 0
0x0271	625	Channel 18 arc alarm status	When the arc intensity of the channel is greater than the alarm threshold, this bit is set to 1; after clearing the alarm, it is set to 0
0x0272	626	Channel 19 arc alarm status	When the arc intensity of the channel is greater than the alarm threshold, this bit is set to 1; after clearing the alarm, it is set to 0
0x0273	627	Channel 20 arc alarm status	When the arc intensity of the channel is greater than the alarm threshold, this bit is set to 1; after clearing the alarm, it is set to 0
0x0274	628	Channel 21 arc alarm status	When the arc intensity of the channel is greater than the alarm threshold, this bit is set to 1; after clearing the alarm, it is set to 0
0x0275	629	Channel 22 arc alarm status	When the arc intensity of the channel is greater than the alarm threshold, this bit is set to 1; after clearing the alarm, it is set to 0
0x0276	630	Channel 23 arc alarm status	When the arc intensity of the channel is greater than the alarm threshold, this bit is set to 1; after clearing the alarm, it is set to 0
0x0277	631	Channel 24 arc alarm status	When the arc intensity of the channel is greater than the alarm threshold, this bit is set to 1; after clearing the alarm, it is set to 0
.....
0x0280	640	Channel 1 current reverse alarm status	This bit is set when the channel current is reversed and greater than the alarm threshold, otherwise cleared.

0x0296	662	Channel 23 current reverse alarm status	This bit is set when the channel current is reversed and greater than the alarm threshold, otherwise cleared.
0x0297	663	Channel 24 current reverse alarm status	This bit is set when the channel current is reversed and greater than the alarm threshold, otherwise cleared.
.....
0x02A0	672	Channel 1 no current alarm status	This bit is set to 1 when there is no current in this channel, otherwise cleared.
0x02A1	673	Channel 2 no current alarm status	This bit is set to 1 when there is no current in this channel, otherwise cleared.
0x02A2	674	Channel 3 no current alarm status	This bit is set to 1 when there is no current in this channel, otherwise cleared.
0x02A3	675	Channel 4 no current alarm status	This bit is set to 1 when there is no current in this channel, otherwise cleared.
0x02A4	676	Channel 5 no current alarm status	This bit is set to 1 when there is no current in this channel, otherwise cleared.
0x02A5	677	Channel 6 no current alarm status	This bit is set to 1 when there is no current in this channel, otherwise cleared.
0x02A6	678	Channel 7 no current alarm status	This bit is set to 1 when there is no current in this channel, otherwise cleared.
0x02A7	679	Channel 8 no current alarm status	This bit is set to 1 when there is no current in this channel, otherwise cleared.
0x02A8	680	Channel 9 no current alarm status	This bit is set to 1 when there is no current in this channel, otherwise cleared.
0x02A9	681	Channel 10 no current alarm status	This bit is set to 1 when there is no current in this channel, otherwise cleared.
0x02AA	682	Channel 11 no current alarm status	This bit is set to 1 when there is no current in this channel, otherwise cleared.
0x02AB	683	Channel 12 no current alarm status	This bit is set to 1 when there is no current in this channel, otherwise cleared.
0x02AC	684	Channel 13 no current alarm status	This bit is set to 1 when there is no current in this channel, otherwise cleared.
0x02AD	685	Channel 14 no current alarm status	This bit is set to 1 when there is no current in this channel, otherwise cleared.
0x02AE	686	Channel 15 no current alarm status	This bit is set to 1 when there is no current in this channel, otherwise cleared.
0x02AF	687	Channel 16 no current alarm status	This bit is set to 1 when there is no current in this channel, otherwise cleared.
0x02B0	688	Channel 17 no current alarm status	This bit is set to 1 when there is no current in this channel, otherwise cleared.
0x02B1	689	Channel 18 no current alarm status	This bit is set to 1 when there is no current in this channel, otherwise cleared.

0x02B2	690	Channel 19 no current alarm status	This bit is set to 1 when there is no current in this channel, otherwise cleared.
0x02B3	691	Channel 20 no current alarm status	This bit is set to 1 when there is no current in this channel, otherwise cleared.
0x02B4	692	Channel 21 no current alarm status	This bit is set to 1 when there is no current in this channel, otherwise cleared.
0x02B5	693	Channel 22 no current alarm status	This bit is set to 1 when there is no current in this channel, otherwise cleared.
0x02B6	694	Channel 23 no current alarm status	This bit is set to 1 when there is no current in this channel, otherwise cleared.
0x02B7	695	Channel 24 no current alarm status	This bit is set to 1 when there is no current in this channel, otherwise cleared.
.....
0x02C0	704	Channel 1 undercurrent alarm status	This bit is set to 1 when the channel is undercurrent, otherwise cleared.
0x02C1	705	Channel 2 undercurrent alarm status	This bit is set to 1 when the channel is undercurrent, otherwise cleared.
0x02C2	706	Channel 3 undercurrent alarm status	This bit is set to 1 when the channel is undercurrent, otherwise cleared.
0x02C3	707	Channel 4 undercurrent alarm status	This bit is set to 1 when the channel is undercurrent, otherwise cleared.
0x02C4	708	Channel 5 undercurrent alarm status	This bit is set to 1 when the channel is undercurrent, otherwise cleared.
0x02C5	709	Channel 6 undercurrent alarm status	This bit is set to 1 when the channel is undercurrent, otherwise cleared.
0x02C6	710	Channel 7 undercurrent alarm status	This bit is set to 1 when the channel is undercurrent, otherwise cleared.
0x02C7	711	Channel 8 undercurrent alarm status	This bit is set to 1 when the channel is undercurrent, otherwise cleared.
0x02C8	712	Channel 9 undercurrent alarm status	This bit is set to 1 when the channel is undercurrent, otherwise cleared.
0x02C9	713	Channel 10 undercurrent alarm status	This bit is set to 1 when the channel is undercurrent, otherwise cleared.
0x02CC	714	Channel 11 undercurrent alarm status	This bit is set to 1 when the channel is undercurrent, otherwise cleared.
0x02CB	715	Channel 12 undercurrent alarm status	This bit is set to 1 when the channel is undercurrent, otherwise cleared.
0x02CC	716	Channel 13 undercurrent alarm status	This bit is set to 1 when the channel is undercurrent, otherwise cleared.
0x02CD	717	Channel 14 undercurrent alarm status	This bit is set to 1 when the channel is undercurrent, otherwise cleared.

0x02CE	718	Channel 15 undercurrent alarm status	This bit is set to 1 when the channel is undercurrent, otherwise cleared.
0x02CF	719	Channel 16 undercurrent alarm status	This bit is set to 1 when the channel is undercurrent, otherwise cleared.
0x02D0	720	Channel 17 undercurrent alarm status	This bit is set to 1 when the channel is undercurrent, otherwise cleared.
0x02D1	721	Channel 18 undercurrent alarm status	This bit is set to 1 when the channel is undercurrent, otherwise cleared.
0x02D2	722	Channel 19 undercurrent alarm status	This bit is set to 1 when the channel is undercurrent, otherwise cleared.
0x02D3	723	Channel 20 undercurrent alarm status	This bit is set to 1 when the channel is undercurrent, otherwise cleared.
0x02D4	724	Channel 21 undercurrent alarm status	This bit is set to 1 when the channel is undercurrent, otherwise cleared.
0x02D5	725	Channel 22 undercurrent alarm status	This bit is set to 1 when the channel is undercurrent, otherwise cleared.
0x02D6	726	Channel 23 undercurrent alarm status	This bit is set to 1 when the channel is undercurrent, otherwise cleared.
0x02D7	727	Channel 24 undercurrent alarm status	This bit is set to 1 when the channel is undercurrent, otherwise cleared.
.....
0x02E0	736	Channel 1 overcurrent alarm status	This bit is set to 1 when the channel is overcurrent, otherwise cleared.
0x02E1	737	Channel 2 overcurrent alarm status	This bit is set to 1 when the channel is overcurrent, otherwise cleared.
0x02E2	738	Channel 3 overcurrent alarm status	This bit is set to 1 when the channel is overcurrent, otherwise cleared.
0x02E3	739	Channel 4 overcurrent alarm status	This bit is set to 1 when the channel is overcurrent, otherwise cleared.
0x02E4	740	Channel 5 overcurrent alarm status	This bit is set to 1 when the channel is overcurrent, otherwise cleared.
0x02E5	741	Channel 6 overcurrent alarm status	This bit is set to 1 when the channel is overcurrent, otherwise cleared.
0x02E6	742	Channel 7 overcurrent alarm status	This bit is set to 1 when the channel is overcurrent, otherwise cleared.
0x02E7	743	Channel 8 overcurrent alarm status	This bit is set to 1 when the channel is overcurrent, otherwise cleared.
0x02E8	744	Channel 9 overcurrent alarm status	This bit is set to 1 when the channel is overcurrent, otherwise cleared.
0x02E9	745	Channel 10 overcurrent alarm status	This bit is set to 1 when the channel is overcurrent, otherwise cleared.

0x02EA	746	Channel 11 overcurrent alarm status	This bit is set to 1 when the channel is overcurrent, otherwise cleared.
0x02EB	747	Channel 12 overcurrent alarm status	This bit is set to 1 when the channel is overcurrent, otherwise cleared.
0x02EC	748	Channel 13 overcurrent alarm status	This bit is set to 1 when the channel is overcurrent, otherwise cleared.
0x02ED	749	Channel 14 overcurrent alarm status	This bit is set to 1 when the channel is overcurrent, otherwise cleared.
0x02EE	750	Channel 15 overcurrent alarm status	This bit is set to 1 when the channel is overcurrent, otherwise cleared.
0x02EF	751	Channel 16 overcurrent alarm status	This bit is set to 1 when the channel is overcurrent, otherwise cleared.
0x02F0	752	Channel 17 overcurrent alarm status	This bit is set to 1 when the channel is overcurrent, otherwise cleared.
0x02F1	753	Channel 18 overcurrent alarm status	This bit is set to 1 when the channel is overcurrent, otherwise cleared.
0x02F2	754	Channel 19 overcurrent alarm status	This bit is set to 1 when the channel is overcurrent, otherwise cleared.
0x02F3	755	Channel 20 overcurrent alarm status	This bit is set to 1 when the channel is overcurrent, otherwise cleared.
0x02F4	756	Channel 21 overcurrent alarm status	This bit is set to 1 when the channel is overcurrent, otherwise cleared.
0x02F5	757	Channel 22 overcurrent alarm status	This bit is set to 1 when the channel is overcurrent, otherwise cleared.
0x02F6	758	Channel 23 overcurrent alarm status	This bit is set to 1 when the channel is overcurrent, otherwise cleared.
0x02F7	759	Channel 24 overcurrent alarm status	This bit is set to 1 when the channel is overcurrent, otherwise cleared.
.....
0x0300	768	Channel 1 current low alarm state	This bit is set to 1 when the channel current is too low, otherwise cleared.
0x0301	769	Channel 2 current low alarm state	This bit is set to 1 when the channel current is too low, otherwise cleared.
0x0302	770	Channel 3 current low alarm state	This bit is set to 1 when the channel current is too low, otherwise cleared.
0x0303	771	Channel 4 current low alarm state	This bit is set to 1 when the channel current is too low, otherwise cleared.
0x0304	772	Channel 5 current low alarm state	This bit is set to 1 when the channel current is too low, otherwise cleared.
0x0305	773	Channel 6 current low alarm state	This bit is set to 1 when the channel current is too low, otherwise cleared.

0x0306	774	Channel 7 current low alarm state	This bit is set to 1 when the channel current is too low, otherwise cleared.
0x0307	775	Channel 8 current low alarm state	This bit is set to 1 when the channel current is too low, otherwise cleared.
0x0308	776	Channel 9 current low alarm state	This bit is set to 1 when the channel current is too low, otherwise cleared.
0x0309	777	Channel 10 current low alarm state	This bit is set to 1 when the channel current is too low, otherwise cleared.
0x030A	778	Channel 11 current low alarm state	This bit is set to 1 when the channel current is too low, otherwise cleared.
0x030B	779	Channel 12 current low alarm state	This bit is set to 1 when the channel current is too low, otherwise cleared.
0x030C	780	Channel 13 current low alarm state	This bit is set to 1 when the channel current is too low, otherwise cleared.
0x030D	781	Channel 14 current low alarm state	This bit is set to 1 when the channel current is too low, otherwise cleared.
0x030E	782	Channel 15 current low alarm state	This bit is set to 1 when the channel current is too low, otherwise cleared.
0x030F	783	Channel 16 current low alarm state	This bit is set to 1 when the channel current is too low, otherwise cleared.
0x0310	784	Channel 17 current low alarm state	This bit is set to 1 when the channel current is too low, otherwise cleared.
0x0311	785	Channel 18 current low alarm state	This bit is set to 1 when the channel current is too low, otherwise cleared.
0x0312	786	Channel 19 current low alarm state	This bit is set to 1 when the channel current is too low, otherwise cleared.
0x0313	787	Channel 20 current low alarm state	This bit is set to 1 when the channel current is too low, otherwise cleared.
0x0314	788	Channel 21 current low alarm state	This bit is set to 1 when the channel current is too low, otherwise cleared.
0x0315	789	Channel 22 current low alarm state	This bit is set to 1 when the channel current is too low, otherwise cleared.
0x0316	790	Channel 23 current low alarm state	This bit is set to 1 when the channel current is too low, otherwise cleared.
0x0317	791	Channel 24 current low alarm state	This bit is set to 1 when the channel current is too low, otherwise cleared.
.....
0x0320	800	Channel 1 current too high alarm state	This bit is set to 1 when the channel current is too high, otherwise cleared.
0x0321	801	Channel 2 current too high alarm state	This bit is set to 1 when the channel current is too high, otherwise cleared.

0x0322	802	Channel 3 current too high alarm state	This bit is set to 1 when the channel current is too high, otherwise cleared.
0x0323	803	Channel 4 current too high alarm state	This bit is set to 1 when the channel current is too high, otherwise cleared.
0x0324	804	Channel 5 current too high alarm state	This bit is set to 1 when the channel current is too high, otherwise cleared.
0x0325	805	Channel 6 current too high alarm state	This bit is set to 1 when the channel current is too high, otherwise cleared.
0x0326	806	Channel 7 current too high alarm state	This bit is set to 1 when the channel current is too high, otherwise cleared.
0x0327	807	Channel 8 current too high alarm state	This bit is set to 1 when the channel current is too high, otherwise cleared.
0x0328	808	Channel 9 current too high alarm state	This bit is set to 1 when the channel current is too high, otherwise cleared.
0x0329	809	Channel 10 current too high alarm state	This bit is set to 1 when the channel current is too high, otherwise cleared.
0x032A	810	Channel 11 current too high alarm state	This bit is set to 1 when the channel current is too high, otherwise cleared.
0x032B	811	Channel 12 current too high alarm state	This bit is set to 1 when the channel current is too high, otherwise cleared.
0x032C	812	Channel 13 current too high alarm state	This bit is set to 1 when the channel current is too high, otherwise cleared.
0x032D	813	Channel 14 current too high alarm state	This bit is set to 1 when the channel current is too high, otherwise cleared.
0x032E	814	Channel 15 current too high alarm state	This bit is set to 1 when the channel current is too high, otherwise cleared.
0x032F	815	Channel 16 current too high alarm state	This bit is set to 1 when the channel current is too high, otherwise cleared.
0x0330	816	Channel 17 current too high alarm state	This bit is set to 1 when the channel current is too high, otherwise cleared.
0x0331	817	Channel 18 current too high alarm state	This bit is set to 1 when the channel current is too high, otherwise cleared.
0x0332	818	Channel 19 current too high alarm state	This bit is set to 1 when the channel current is too high, otherwise cleared.
0x0333	819	Channel 20 current too high alarm state	This bit is set to 1 when the channel current is too high, otherwise cleared.
0x0334	820	Channel 21 current too high alarm state	This bit is set to 1 when the channel current is too high, otherwise cleared.
0x0335	821	Channel 22 current too high alarm state	This bit is set to 1 when the channel current is too high, otherwise cleared.
0x0336	822	Channel 23 current too high alarm state	This bit is set to 1 when the channel current is too high, otherwise cleared.

0x0337	823	Channel 24 current too high alarm state	This bit is set to 1 when the channel current is too high, otherwise cleared.
--------	-----	---	---

7.4.2 Register description in word unit (function code 03 04 06)

Modbus address		Function description	Data Type	instruction	R/ W
Hex	Decimal				
Address 0x0100 ~ 0x0158, a total of 89 consecutive addresses					
Address 0x0100 ~ 0x0123, a total of 36 consecutive addresses (data in this address supports data freeze)					
0x0104	260	bus voltage	Unsigned short	Unit V, default 0	R
0x0105	261	Temperature sensor 1	short	Unit: 0.1 ° C, default -424	R
0x0106	262	Temperature sensor 2	short	Unit: 0.1 ° C, default -424	R
0x0107	263	Switch input	Unsigned short	bit0: DI1, bit1: DI2, bit2: DI3, bit3: DI4 0: open, 1: closed, default 0	R
0x0108	264	Quantity of online Hall channels	Unsigned short	Shows the quantity of Hall channels currently connected. default 0	R
0x0109	265	Total reverse current	short	Unit is 10mA, default is 0	R
0x010A	266	Total current	Short	Unit is 10mA, default is 0,	R
0x010B	267	Average current	Short	Unit mA, default 0	
0x010C ~ 0x0123	268 ~ 291	Channel 1 to 24 current	Short	Unit mA, default 0	R
Address 0x012A ~ 0x0158, a total of 45 addresses (function code 04 read, but the data is not latched)					
0x012A	298	Shunt trip status 1	Unsigned short	Bit0 bus arc, the trip code is (01) Bit1 channel arc, (02) Bit3 overvoltage, (04) Bit4 high temperature 1, (05) Bit5 high temperature 2, (06) Bit6 channel current value is reversed, (07) Bit7 Total reverse current is high, (08) Bit9 total current is high, (10) Bit10 channel current value is zero, (11) Bit11 channel current value undercurrent, (12) Bit12 channel current value overcurrent, (13) Bit13 channel current value is low, (14) Bit14 channel current value is high, (15) Bit15 reserved, (16) 0: No tripping, 1: Tripped, default 0	R
0x012B	299	Shunt trip status 2	Unsigned short	Bit0 DI1, (17) Bit1 DI2, (18) Bit2 DI3, (19) Bit3 DI4, (20) Bit4 combined alarm Bit14: Tripped remotely, (31) 0: No tripping, 1: Tripped, default 0	R
0x012C	300	Shunt trip status 3	Unsigned short	Bit15: Total trip status (not open) 0: no trip, 1: tripped, default 0	
0x012D	301	Alarm status 1	Unsigned short	Bit0 bus bar arc, Bit1 channel arc, Bit2 low voltage, Bit3 high voltage, Bit4 high temperature 1, Bit5 high temperature 2, Bit6 channel current value reverse Bit7 total reverse current is high,	R

				Bit8 total current is low, Bit9 total current is high, Bit10 channel current value is zero, Bit11 channel current value undercurrent Bit12 channel current value overcurrent Bit13 channel current value is low Bit14 channel current value is high 0: no alarm, 1: alarm, default 0	
0x012E	302	Alarm status 2	Unsigned short	Bit0 DI1 Bit1 DI2 Bit2 DI3 Bit3 DI4 Bit4 combined alarm 0: no alarm, 1: alarm, default 0	
0x0130	304	Channel 1 ~ 16 arc alarm	Unsigned short	Default 0 0: No alarm, 1: Alarm	R
0x0131	305	Channel 17 ~ 24 arc alarm	Unsigned short	Default 0 0: No alarm, 1: Alarm	R
0x0132	306	The quantity of Bus arc history alarm	Unsigned short	If the current channel alarms continuously, the value will increase by 1. If there are alarms on other channels, the count will restart.	R
0x0133 ~ 0x014A	307 ~ 330	The quantity of Channel 1~24 arc history alarm	Unsigned short	default 0 This value is incremented by 1 for each channel arc alarm.	R
0x014B	331	Channel 1 ~ 16 reverse current alarm	Unsigned short	Default 0 0: No alarm, 1: Alarm	R
0x014C	332	Channel 17 ~ 24 reverse current alarm	Unsigned short	Default 0 0: No alarm, 1: Alarm	R
0x014D	333	Channel 1 ~ 16 no current alarm	Unsigned short	Default 0 0: No alarm, 1: Alarm	R
0x014E	334	Channel 17 ~ 24 no current alarm	Unsigned short	Default 0 0: No alarm, 1: Alarm	R
0x014F	335	Channel 1 ~ 16 undercurrent alarm	Unsigned short	Default 0 0: No alarm, 1: Alarm	R
0x0150	336	Channel 17 ~ 24 undercurrent alarm	Unsigned short	Default 0 0: No alarm, 1: Alarm	R
0x0151	337	Channel 1 ~ 16 overcurrent alarm	Unsigned short	Default 0 0: No alarm, 1: Alarm	R
0x0152	338	Channel 17 ~ 24 overcurrent alarm	Unsigned short	Default 0 0: No alarm, 1: Alarm	R
0x0153	339	Channel 1 ~ 16 current low alarm	Unsigned short	Default 0 0: No alarm, 1: Alarm	R
0x0154	340	Channel 17 ~ 24 current low alarm	Unsigned short	Default 0 0: No alarm, 1: Alarm	R
0x0155	341	Channel 1 ~ 16 current high alarm	Unsigned short	Default 0 0: No alarm, 1: Alarm	R
0x0156	342	Channel 17 ~ 24 current high alarm	Unsigned short	Default 0 0: No alarm, 1: Alarm	R
0x0157	343	Channel 1 ~ 16 arc channel self-check status	Unsigned short	default 0 ,0 means self-check passed, 1 means self-check failed	R
0x0158	344	Channel 17 ~ 24 arc channel self-check status	Unsigned short	default 0 ,0 means self-check passed, 1 means self-check failed	R

The address 0x0200 ~ 0x02FF, which has a total of 128 consecutive addresses. It is recommended to read in sections.

Power information (0x0200-0x024b)					
0x0200	512	Total power	Unsigned short	Unit is 100W, default 0	R
0x0201	513	Average power	Unsigned short	Unit is W, default 0, the unit is 10W when using a large range of Hall	R
0x0202 ~ 0x0219	514 ~ 537	Channel 1 ~ 24 power	Unsigned short	Unit W, default 0	R
0x021A	538	The higher 16bit of the total generated energy	Unsigned short	Unit Wh, default 0	R
0x021B	539	The lower 16bit of the total generated energy	Unsigned short	Unit Wh, default 0	R
0x021C	540	The higher 16bit of the generated energy of channel1	Unsigned short	Unit Wh, default 0	R
0x021D	541	The lower 16bit of the generated energy of channel1	Unsigned short	Unit Wh, default 0	R
.....
0x024A	586	The higher 16bit of the generated energy of Channel 24	Unsigned short	Unit Wh, default 0	R
0x024B	587	The lower 16bit of the generated energy of Channel 24	Unsigned short	Unit Wh, default 0	R
Arc information (0x0250-0x0297)					
0x0250 ~ 0x0267	592 ~ 615	Channel 1~24 arc intensity real-time value	short	Unit 1, default 0	R
0x0268 ~ 0x027F	616 ~ 639	Channel 1~24 arc intensity history maximum	short	Unit 1, default 0	R
0x0280 ~ 0x0297	640 ~ 663	Channel 1~ 24 10 minutes arc intensity value	short	Unit 1, default 0	R
FR-DCMG-HS4Q Hall special register (0x0400-0x0431)					
0x0400	1024	Current value of current channel 1	short	Unit 10mA, default 0	
0x0401	1025	Current value of current channel 2	short	Unit 10mA, default 0	
.....		
0x0416	1046	Current value of current channel 23	short	Unit 10mA, default 0	
0x0417	1047	Current value of current channel 24	short	Unit 10mA, default 0	
0x0418	1048	Total reverse current	short	Unit 100mA, default 0	
0x0419	1049	Total current	short	Unit 100mA, default 0	
0x041A	1050	Average current	short	Unit 10mA, default 0	
0x041B	1051	Total power	short	Unit 1000W, default 0	
0x041C	1052	Average power	short	Unit 10W, default 0	
0x041D ~ ~	1053 ~ ~	Channel 1 ~ 24 power	short	Unit 10W, default 0	

0x0434	1076				
FR-DCMG-HS4Q Hall special register Large-range energy information (0x0500-0x0540)					
0x0500	1280	The higher 16bit of the total generated energy	Unsigned short	Unit 10W, default 0	
0x0501	1281	The lower 16bit of the total generated energy	Unsigned short	Unit 10W, default 0	
0x0502	1282	The higher 16bit of the generated energy of channel1	Unsigned short	Unit 10W, default 0	
0x0503	1283	The lower 16bit of the generated energy of channel1	Unsigned short	Unit 10W, default 0	
.....		
0x0539	1343	The higher 16bit of the generated energy of Channel 24	Unsigned short	Unit 10Wh, default 0	
0x0540	1344	The lower 16bit of the generated energy of Channel 24	Unsigned short	Unit 10Wh, default 0	
System information configuration (0x0B00-0x0B24)					
0x0B00	2816	Alarm release	Unsigned Short	The percentage of the alarm threshold is used as the alarm release threshold. Unit %, default 2, setting range 0 to 100	W/R
0x0B01	2817	Bus voltage alarm low threshold	Unsigned short	Unit V, default 300	W/R
0x0B02	2818	Bus voltage alarm high threshold	Unsigned short	Unit V, default 1500	W/R
0x0B03	2819	Temperature sensor 1 alarm high threshold	short	Unit 0.1 ° C, default 800, setting range is greater than -400	W/R
0x0B04	2820	Temperature sensor 2 alarm high threshold	short	Unit 0.1 ° C, default 800, setting range is greater than -400	W/R
0x0B05	2821	Total current low alarm threshold	Unsigned Short	Unit 10mA, default 1600	W/R
0x0B06	2822	Total current too high alarm threshold	Unsigned Short	Unit 10mA, default 50000	W/R
0x0B07	2823	Current channel related alarm activation threshold	Unsigned Short	Unit mA, default 2000. The average current value is greater than this value; the total current is too high, too low, the channel is undercurrent, overcurrent, no current, high current, low current, otherwise these alarms will be forcibly turned off.	W/R
0x0B08	2824	Undercurrent, overcurrent alarm threshold	Unsigned short	Unit mA, default 2000. The average current is subtracted from this value as the undercurrent alarm threshold; the average current is added to this value as the overcurrent alarm threshold.	W/R
0x0B09	2825	Channel current low alarm threshold	Unsigned short	Unit mA, default 1000.	W/R
0x0B0A	2826	Channel current high alarm threshold	Unsigned short	Unit mA, default 20000.	W/R
0x0B0B	2827	Reverse total current too high threshold	short	Unit 10mA, default -600.	W/R
0x0B0C	2828	Channel reverse current too high threshold	short	Unit mA, default -2000.	W/R
0x0B0D	2829	Current channel related trip	Unsigned	Default 3. When the channel is reversed,	W/R

		threshold	short	undercurrent, overcurrent, no current, high current, and the number of channels with low current is greater than or equal to this value, the trip unit performs the tripping action. Otherwise it will not work.	
0x0B0E	2830	Channel arc intensity super high alarm threshold	Short	The default is 50. Need to set according to the site conditions or customer requirements, you can call the company's technical staff	W/R
0x0B0F	2831	O + O- output level during alarm	Bool	0: low level; 1: 24V, Release mode: default is 1; Relay mode: the default is 0;	W/R
0x0B10	2832	O + O- output time during alarm	Unsigned short	Unit S (seconds), Release mode: default is 1; Relay mode: default is 180	W/R
0x0B11	2833	Automatic current calibration setting	Bool	Write 1 to enable automatic current calibration, write 0 to disable, default is 0	W/R
0x0B12	2834	Manual current calibration setting	Bool	Write 1 to start current calibration, write 0 to turn off, default is 0 Note: Make sure the channel has no current when starting calibration.	W/R
0x0B13	2835	Channel 1~16 current channel switch setting	Unsigned short	bit0: Represents the switch setting for channel 1 bit15: Represents the switch setting for channel 16 0 means disabled, 1 means enabled Default 0xFFFF	W/R
0x0B14	2836	Channel 17~24 current channel switch setting	Unsigned short	bit0: Represents the switch setting for channel 7 bit7: Represents the switch setting for channel 24 0 means disabled, 1 means enabled Default 0xFFFF	W/R
0x0B16	2838	Current UI display, direction, reverse order control	Unsigned short	0 means that the maximum current displayed on the UI interface is 10A 1 indicates that the maximum current displayed on the UI interface is 20A 2 indicates that the maximum current displayed on the UI interface is 30A 3 means that the UI interface shows a maximum current of 40A Bit8: Current channel positive sequence/reverse sequence setting (Positive sequence: Hall close to the host is arranged according to channels 1~24; Reverse sequence: Hall close to the host is calculated according to channels 24 to 1) 0 means positive order; 1 means reverse order Bit9: Channel current direction setting 0 means that the direction is positive, and 1 means that the current is reversed.	W/R

				Bit10: Auto range enable The default is 0x0401;	
0x0B17	2839	Arc output mode setting	Unsigned short	0: Tripper mode; 1: Relay mode Default value: 1	W/R
0x0B18	2840	Arc detection mode	Unsigned short	0: Instantaneous arc; 1: Continuous arc Default value: 1	W/R
0x0B19	2841	Instantaneous arc time IAT	Unsigned short	2-5 Default value: 2	W/R
0x0B1A	2842	Continuous arc time CAT	Unsigned short	15-60 Default value: 15	W/R
0x0B20	2848	Alarm function management 1	Unsigned short	Bit0 bus bar arc, Bit1 channel arc, Bit2 low voltage, Bit3 high voltage, Bit4 high temperature 1, Bit5 high temperature 2, Bit6 channel current value is reversed, Bit7 total reverse current is high, Bit8 total current is low, Bit9 total current is high, Bit10 channel current value is zero, Bit11 channel current value undercurrent, Bit12 channel current value is overcurrent, Bit13 channel current value is too low, Bit14 channel current value is too high, 1: Enable (open) alarm, 0: Disable (close) alarm Default: 0x0002	W/R
0x0B21	2849	Alarm function management 2 (Combined alarm management 1)	Unsigned short	Bit0 DI1 Bit1 DI2 Bit2 DI3 Bit3 DI4 Bit4 combined alarm switch Bit14: remote trip, Bit15: Alarm switch, (the function is forcibly turned on) 1: Enable alarm, 0: Disable alarm Default value: 0x800F	W/R
0x0B23	2851	Alarm trip action management 1	Unsigned short	Bit0 bus bar arc, Bit1 channel arc, Bit2 low voltage, Bit3 high voltage, Bit4 high temperature 1, Bit5 high temperature 2, Bit6 channel current value is reversed, Bit7 total reverse current is high, Bit9 total current is high, Bit10 channel current value is zero, Bit11 channel current value undercurrent, Bit12 channel current value is overcurrent, Bit13 channel current value is too low, Bit14 channel current value is too high, 1: Enable (open) trip, 0: Disable (close)	W/R

				trip Default: 0x0002	
0x0B24	2852	Alarm trip action management 2	Unsigned short	Bit0 DI1, Bit1 DI2, Bit2 DI3, Bit3 DI4 Bit4 combined alarm switch Bit14: remote trip, Bit15 alarm trip main switch, (the function is forcibly opened) 1: Enable (open) trip, 0: Disable (close) trip Default: 0x8000	W/R
0x0B26	2854	Logic AND Alarm Ctrl 1	Unsigned short	bit0 AndEn_bus arc, bit1 AndEn_channel arc, bit2 AndEn_low voltage, bit3 AndEn_High pressure, bit4 AndEn_high temperature 1, bit5 AndEn_high temperature 2, bit6 AndEn_channel current value is reversed, bit7 AndEn_total reverse current high, bit9 AndEn_total current high, bit10 AndEn_channel current value is zero, bit11 AndEn_channel current value flow, bit12 AndEn_channel current value is overcurrent, bit13 AndEn_channel current value is too low, bit14 AndEn_channel current value is too high, 1: Participate in combinational logic, 0: Not participate in combinational logic Default: 0x0000	W/R
0x0B27	2855	Logic AND Alarm Ctrl 2	Unsigned short	Bit0 AndEn_DI1 , bit1 AndEn_DI2 , bit2 AndEn_DI3 , bit3 AndEn_DI4 1: Participate in combinatorial logic, 0: Do not participate in combinatorial logic Default: 0x0000	W/R
System information configuration 2 (0x0C00-0x0C06)					
0x0C00	3072	Clear power generation history value record	Unsigned short	Write 1 reset energy history record, read always 0	W/R
0x0C01	3073	Clear channel arc and bus arc history alarms	Unsigned short	Write 1 reset channel arc and bus arc history alarm times record, read always 0	W/R
0x0C02	3074	Clear alarm trip status information and alarm interface	Unsigned short	Write 1 reset trip alarm status information and alarm interface, read always 0.(remove interface and status information related to trip management)	W/R
0x0C03	3075	Retain			
0x0C04	3076	Remote manual control release performs tripping	Unsigned short	Write 1 manually to control the trip unit to perform the tripping action, and the read is always 0	W/R

				Note: The remote alarm trip enable must be turned on first (write 1 for bit14 of 0xb21 and bit14 of 0xb24)	
0x0C05	3077	Arc channel self-check operation	Unsigned short	Write 1 to start the arc channel self-check, 1S to end the self-check. read always 0	W/R
0x0C06	3078	Retain			
System settings (0xFE00-0xFE54)					
0xFE00	65024	Modbus address	Unsigned short	Set range 1 ~ 247, default 247. Set other values to restore the default values.	W/R
0xFE01	65025	Modbus Baud rate	Unsigned short	1: 2400, 2: 4800, 3: 9600, 4: 19200, 5: 38400 Default is 3, setting other values to restore the default	W/R
0xFE02	65026	Modbus Parity	Unsigned short	0: NONE, 1: ODD, 2: EVEN Default is 0, setting other values to restore the default	W/R
0xFE06	65030	System UI display settings	Unsigned short	Lower 8 bits: system language setting 0: Chinese; 1: English, default value 1 High eight bits: system logo settings Reserved, default 0	W/R
0xFFCC	65484	Automatic recovery times of arc alarm	Short	Unit 1, default 5. Only effective in relay mode	W/R

8.1 Document revision record

Revision	Time	Description
1.0	2020-03-12	<p>For A088 and above products Update switch description, terminal definition, new setting interface and alarm interface; Add ——Arc Intensity 10 Minute Value Register ——Arc Alarm Strategy —— Trip mode high-low level switching function, interface and register ——Communication shielded wire wiring specification ——Current calibration function, interface and register ——FAQ (screen flicker troubleshooting method) ——PLC System diagram ——Parameter setting range Deletion——Broadcast, battery board and other registers</p>
1.1	2020-04-28	<p>Add——FR-DCMG-HS4Q Hall Register ——DC 24V power supply wiring</p>
1.2	2020-07-03	<p>Add——HS4Q long range register 0x0400, 0x0500</p>
1.3	2021-04-19	<p>Add——combined alarm strategy ——Combined alarm register 0x0B21, 0x0B24 ——The status of the combined alarm 03 The position of the function code is in bit 4 of the register 0x12B and 0x12E ——Combined alarm status 02 The position of function code is 0x214 in the register</p>
1.4	2021-05-15	<p>Add——safety precautions ——installation method</p>
1.5	2021-09-16	<p>Software version: A08D: Combination alarm function bugfix, page name adjustment, 0xb18 arc mode (0 instantaneous arc, 1 continuous arc), 0xb19 instantaneous arc IAT function, and 0xb1a continuous arc CAT function.</p> <p>Add-UI setting interface, new MOD, IAT, CAT parameter setting options ——Combined alarm logic, closed by default ——Interpretation of arc alarm terms, interpretation of instantaneous arc and continuous arc ——Data message example ——0x0B18 Arc detection mode register 0x0B19 continuous arc IAT 0x0B1A continuous arc CAT Delete-PLC function description, PLC function in FR-DCMG-MMPL</p>

		manual Modification-optimized text description of alarm conditions Add-add 0xFFCC register
--	--	--

8.2 Contact us

If you have any questions about this product, please contact us. Please remember the following contact information:

Fonrich (Shanghai) New Energy Technology Co., Ltd.

Add: 1st Floor, Building 5, No.999 Jiangyue Road, Minhang District, Shanghai

Zip code: 201114 Tel :+86 21 61679672

Fax:+86 21 60717306 Email: sales@fonrich.com

Website: www.fonrich.com